

**Strength, Style and Security
for your home and family**



SENTINEL



Why Sentinel Impact Resistant Windows and Doors?



Sentinel by CGI has received the prestigious 2011 Crystal Achievement Award.

An investment in hurricane impact resistant Sentinel Windows and Doors for your home or commercial property is a very wise decision. Sentinel Windows and Doors are manufactured and backed by CGI, founded in 1992 and one of the original pioneers in design and manufacture of high performance impact hurricane resistant windows and doors. CGI's reputation for building high quality windows and doors makes CGI's products the preferred choice of architects, developers, builders and homeowners wherever impact resistant windows and doors are required.

Sentinel's complete line of windows and doors are custom manufactured to enhance the aesthetics of every



architectural style while delivering protection from the most extreme weather conditions.

Sentinel Windows and Doors are the best choice to satisfy your window and door needs. Contact a Sentinel dealer today to learn more and see why an investment in Sentinel is the right decision and an outstanding value.

Selecting Sentinel as your window and door choice is also a smart investment for the following reasons:

- Sentinel impact resistant products increase the resale value of your property
- Sentinel impact products will lower your property insurance premiums in most instances
- Sentinel's laminated impact glass reduces energy requirements for heating and cooling your property
- Sentinel laminated impact glass provides improved security against intruders
- Sentinel's laminated glass eliminates up to 99% of UV ray damage to your interior furnishings
- Sentinel's laminated impact glass reduces outside noise transmission into the interior of your home or property



SENTINEL Advantage

Up to 30% thicker aluminum extrusions

THEIRS

Thinner aluminum gauge provides less strength and sturdiness

SENTINEL

Up to 30% thicker aluminum extrusions for superior strength

Uneven sightlines

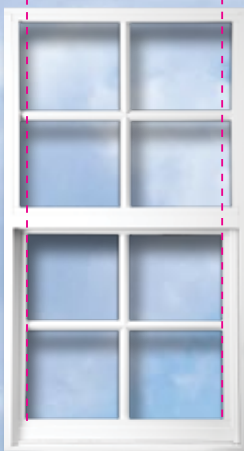

Architecturally correct sightlines



THEIRS

Difference in thickness of top and bottom sash construction is less aesthetically pleasing

SENTINEL

Matching top and bottom sash sightlines offer a high-end symmetrical look to your home

Unightly protruding top rail



Smooth flush appearance



THEIRS

Protruding rail that detracts from appearance

SENTINEL

Better aesthetics with our flush design

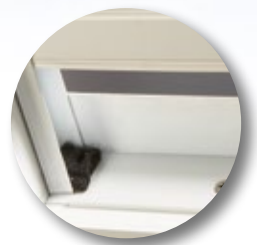

THEIRS

Open L-frame design reduces structural integrity. Unightly foam pads capture dirt and tend to fall off or get removed

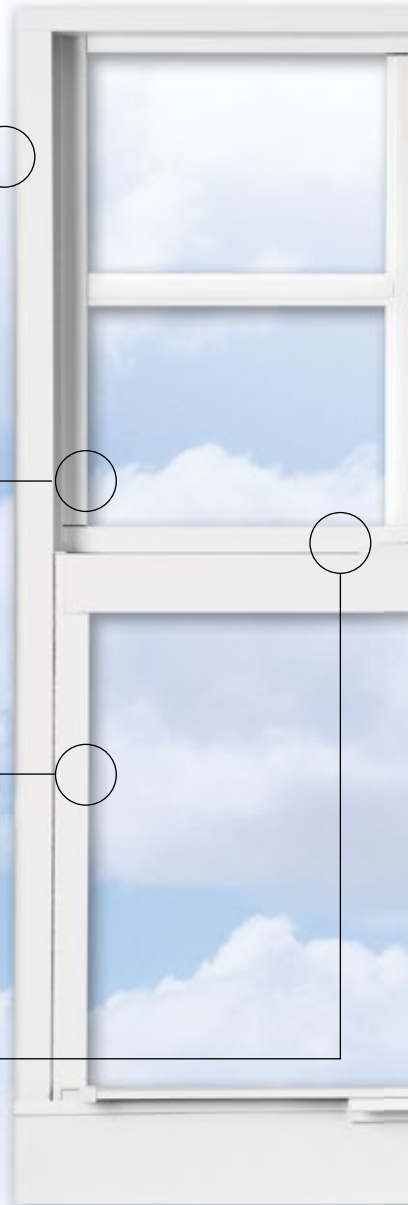



Larger stainless steel fasteners



SENTINEL
CGI offers superior frame construction design because we fasten our frame corners using three #10-1 ¼ inch stainless steel fasteners

THEIRS
Smaller and fewer #8-1 inch screws provide less frame strength, product longevity and hurricane resistance

Hidden balances



SENTINEL
Features hidden balances for a cleaner, neater look (most sizes)

THEIRS
Exposed hardware detracts from appearance

Captured bottom rail



SENTINEL
Superior captured bottom rail u-frame design for improved strength and protection from water infiltration

Triple Weatherstripping

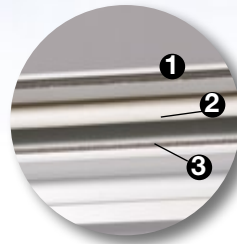

SENTINEL
Triple weatherstripping at the sill creates superior energy efficient air and water infiltration protection

THEIRS
One row of weatherstripping. More likely to leak resulting in energy loss and water intrusion

Reduce energy costs with energy saving options.

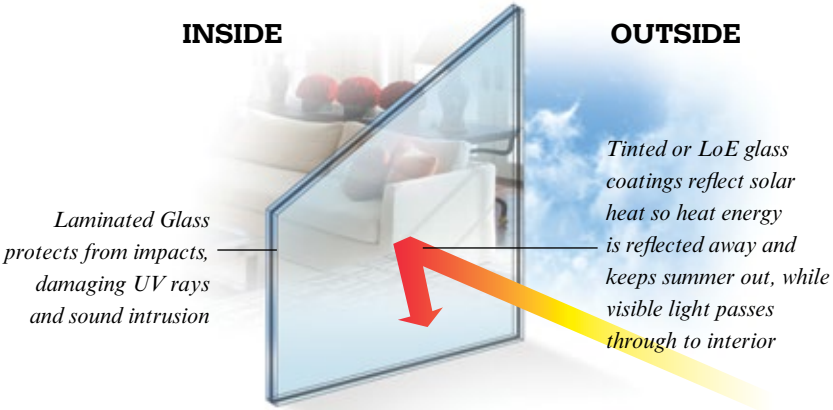

Save on your heating and cooling bill by combining energy efficient glass choices including glass tints, LoE and insulated glass.

Combine the advantages of impact protection and energy savings with Sentinel windows and doors. Save on your heating and cooling bill by selecting from a wide variety of energy efficient glass choices including tinted glass, LoE coatings and insulated glass. Choose your glass type based on where you live and your budget. For example, tinted laminated glass may be the most cost effective impact resistant glazing option. Consider tinted laminated for warm climates such as Florida, the Caribbean, Hawaii, and coastal areas of South Carolina, Alabama, Mississippi, and Louisiana. If you are looking for higher performance glass options, laminated glass with a LoE coating or insulated laminated glass with a LoE coating is available. These high performance glass options are perfect for



cooler climates such as North Carolina, inland sections of South Carolina, Alabama, Mississippi and Louisiana, as well as anywhere required by local building codes. Please contact a Sentinel dealer for more information.

Easy Retrofit

Sentinel is custom manufactured to exact sizes within our wide range of design parameters therefore reducing on-site construction costs. In addition, Sentinel's frame depth is designed for both new construction and replacement applications resulting in faster, less intrusive installations. Uniquely designed, Sentinel products are the best choice for your remodeling project. Improve the value, energy efficiency and aesthetics of your property by selecting Sentinel windows and doors.

Superior Warranty Coverage

Sentinel products are backed by our long standing comprehensive product warranty. Ask your local Sentinel dealer for details or visit our website at www.cgiwindows.com





Single Hung



Fixed



Horizontal Rolling



Casement/Project Out



Designer



French Door



Sliding Glass Door

The closer you look, the better Sentinel looks



Egress Self Closing or Sweep Lock



Semi-Contoured Muntins

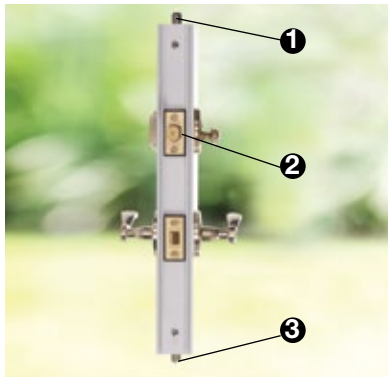

Three Point Locking System



Sliding Glass Door Mitered Corner

Super-View™ Screen



Our Super-View™ see-through screen material provides strong construction and clearer, unobstructed views. Our screens are constructed using a sturdy extruded frame design.

Choose from a number of beautiful designer configurations

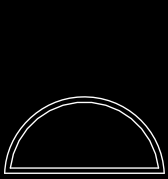

Half circle



Arch top /
eyebrow

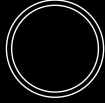

Full circle



Oval



Octagon



Hexagon



Chord

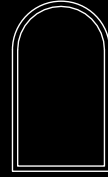

Tombstone

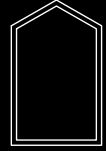

Pentagon



Gothic
pentagon

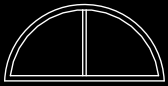

2-lite half circle
or 2 x 1



4-lite half circle



4-lite sunburst



5-lite sunburst



Custom
colonial



Custom
colonial

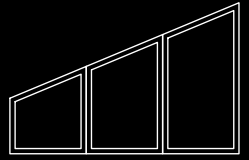

Trapezoid

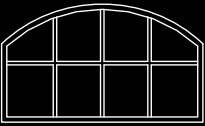

4 x 2 eyebrow

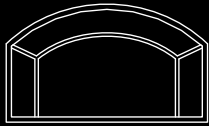

4-lite sunburst
eyebrow

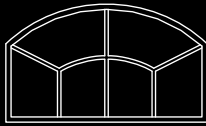

Custom
colonial

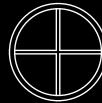

4-lite full circle
or 2 x 2

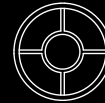

Custom
colonial

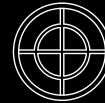

Custom
colonial

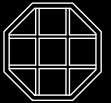

9-lite
octagon

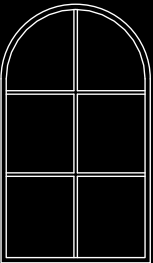

2 x 3
Tombstone

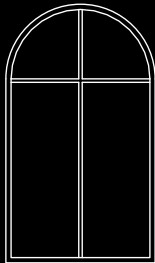

Custom
colonial

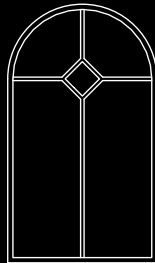

Custom
colonial

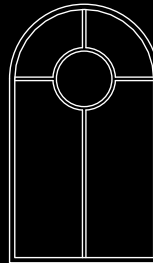

Custom
colonial

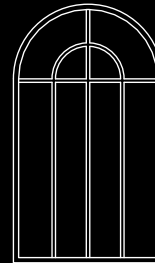

Custom
colonial

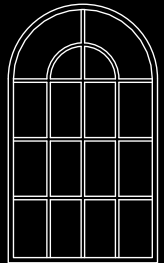

Custom
colonial

Sentinel Products Offer Many Customizable Choices

Frame Color

- White
- Clear Anodized
- Bronze

Glass Types

- Laminated
- Insulated Laminated

Glass Tints

- Clear
- Gray
- Dark Gray (turtle code)
- Bronze
- Solexia Green
- White Interlayer
- Mist (Pattern 62)
- Rain

Glass Coatings

- Energy Efficient LoE options

Muntin/Grid Design

- Large assortment of muntin designs

Single Hung

- Sash bottom rail mounted egress lock standard
- Sash top rail mounted sweep lock option
- Concealed head installation screws
- Stainless steel fasteners standard
- Extruded screen frame with Super-View™ screen mesh standard

Horizontal Rolling Window

- Two & Three panel configurations OX, XO, XOX
- Sash handle rail mounted egress lock standard
- Sash interlock rail mounted sweep lock option
- Concealed jamb anchors
- Stainless steel fasteners standard
- Extruded screen frame with Super-View™ screen mesh standard

Casement

- Stainless steel operator standard
- Stainless steel 4 bar hinges standard
- Stainless steel fasteners
- Extruded screen frame with Super-View™ screen mesh standard

Project Out

- Stainless steel dual arm operator standard
- Stainless steel 4 bar concealed hinges standard
- Stainless steel fasteners
- Extruded screen frame with Super-View™ screen mesh standard

Sliding Glass Doors

- Two & Three track configurations
- Pocketing panel options
- Exterior keyed security lock option
- Stainless steel fasteners standard
- Single & dual track extruded frame with Super-View™ screen

Available Finishes:

- White, Bronze and Class I Clear Anodized

Standard Glass Colors:

- Clear, Gray, Dark Gray (turtle code), Bronze, Solexia Green, White Interlayer, Mist (Pattern 62), Rain

Glass Types:

- 5/16" Laminated
- 3/4" Insulated Laminated

Glass Coatings:

- Energy efficient LoE options

Standard Hardware:

- Egress self closing lock (sill mounted)

Standard Features:

- Matching top and bottom sightlines
- Flush design
- U-framed captured bottom rail with triple weatherstripping and weeped sill
- 2 1/2" deep frame
- Hidden block and tackle balances (most sizes)
- Extruded snap-on square glazing beads
- Strong structural glazing
- Concealed head anchors
- (3) #10-1 1/4" stainless steel fasteners per corner
- Extruded screen frame with Super-View™ fiberglass mesh

Optional Items:

- Meeting rail mounted sweep locks
- Uneven size vent windows (Oriol)
- Flange, fin & equal leg frame options
- Additional egress self closing lock

Optional Muntins:

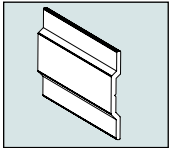

Low Profile

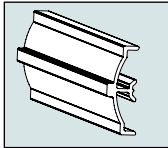

Semi-Contoured (exterior only)

Glass Types:



Laminated Glass



Insulated Laminated Glass

Sentinel Single Hung Window 110

Available with Sentinel clipless mullions that are flush on the interior. Concealed balances and stainless steel package comes standard. Architecturally correct sightlines.

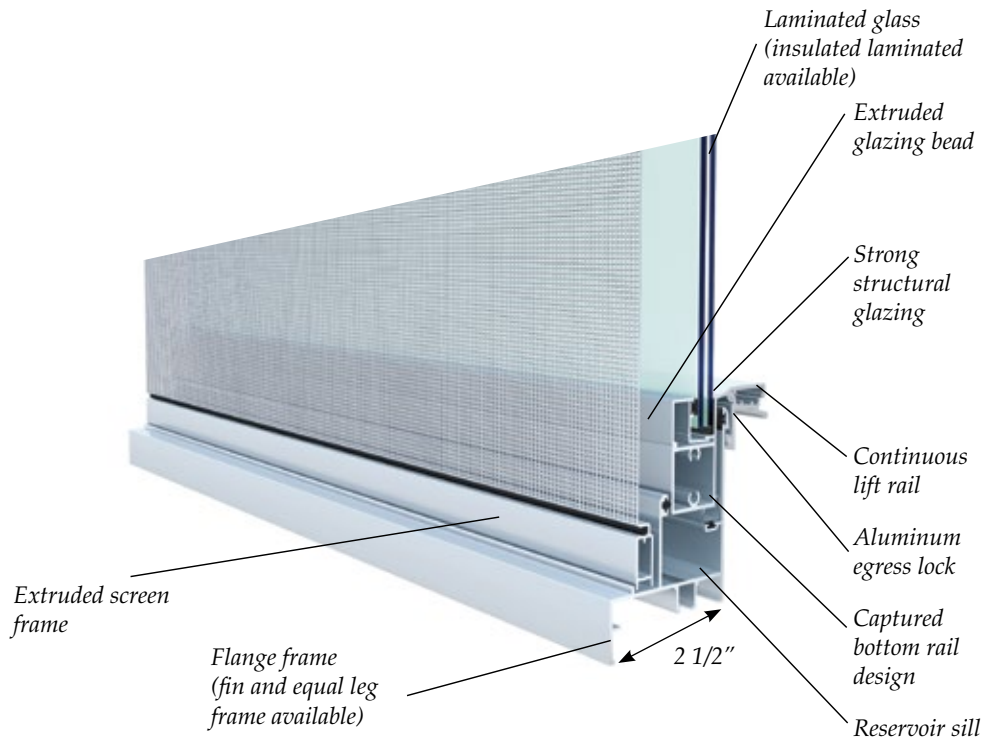

Sentinel Single Hung Window 110

Commodity Sizes (In inches)

Width	Height	Width	Height	Width	Height	Width	Height
19 1/8	26	26 1/2	26	37	26	53 1/8	26
19 1/8	38 3/8	26 1/2	38 3/8	37	38 3/8	53 1/8	38 3/8
19 1/8	50 5/8	26 1/2	50 5/8	37	50 5/8	53 1/8	50 5/8
19 1/8	59 1/2	26 1/2	59 1/2	37	59 1/2	53 1/8	59 1/2 e
19 1/8	63	26 1/2	63	37	63	53 1/8	63 e
19 1/8	76	26 1/2	76	37	76 e	53 1/8	76 e

All single hung windows have a 2 1/2" depth, ideal for replacement applications
e=Meets clear opening egress requirements at 5.7 sq. ft.

Modular Sizes (In inches)

Width	Height	Width	Height	Width	Height	Width	Height	Width	Height
24	26	32	26	40	26	44	26	48	26
24	38 3/8	32	38 3/8	40	38 3/8	44	38 3/8	48	38 3/8
24	50 5/8	32	50 5/8	40	50 5/8	44	50 5/8	48	50 5/8
24	59 1/2	32	59 1/2	40	59 1/2 e	44	59 1/2 e	48	59 1/2 e
24	63	32	63	40	63 e	44	63 e	48	63 e
24	76	32	76	40	76 e	44	76 e	48	76 e

All single hung windows have a 2 1/2" depth, ideal for replacement applications

Performance Results

Maximum Water Resistance		12 PSF
Large Missile	53 1/8" x 76" window (Ann/Ann Glass)	+75 PSF /-75 PSF
	53 1/8" x 76" window (HS/HS Glass)	+80 PSF /-85 PSF
Forced Entry Test (AAMA 1302.5)		Passed

Small missile performance results available upon request.

Energy Values (NFRC Approved)

Laminated		U Factor	SHGC	VT
5/16"	Clear LoE 366	1.05	0.29	.46
5/16"	Gray	1.04	0.49	.44
5/16"	Clear	1.04	0.59	.66
Insulated Laminated				
3/4"	Clear LoE 366	0.60	0.23	.47
3/4"	Clear LoE 270	0.60	0.30	.51

Available Finishes:

- White, Bronze and Class I Clear Anodized

Standard Glass Colors:

- Clear, Gray, Dark Gray (turtle code), Bronze, Solexia Green, White Interlayer, Mist (Pattern 62), Rain

Glass Types:

- 5/16" Laminated
- 3/4" Insulated Laminated

Glass Coatings:

- Energy efficient LoE options

Standard Hardware:

- Egress lock

Standard Features:

- Two & three panel configurations OX, XO, XOX
- Equal lites or 1/4-1/2-1/4 configuration
- Flush design
- Double weatherstripping and weeped sill
- 2 1/2" deep frame
- Extruded snap-on square glazing beads
- Strong structural glazing
- Concealed jamb anchor cover
- (3) #10-1 1/4" stainless steel fasteners per corner
- Extruded screen frame with Super-View™ fiberglass mesh

Optional Items:

- Sash interlock rail mounted sweep lock
- Flange, fin & equal leg frame options

Optional Muntins:

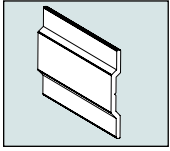

Low Profile

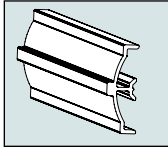

Semi-Contoured (exterior only)

Glass Types:



Laminated Glass



Insulated Laminated Glass

Sentinel Horizontal Rolling Window 120

Available with Sentinel clipless mullions that are flush on the interior. Stainless steel package comes standard. Super smooth rolling action.

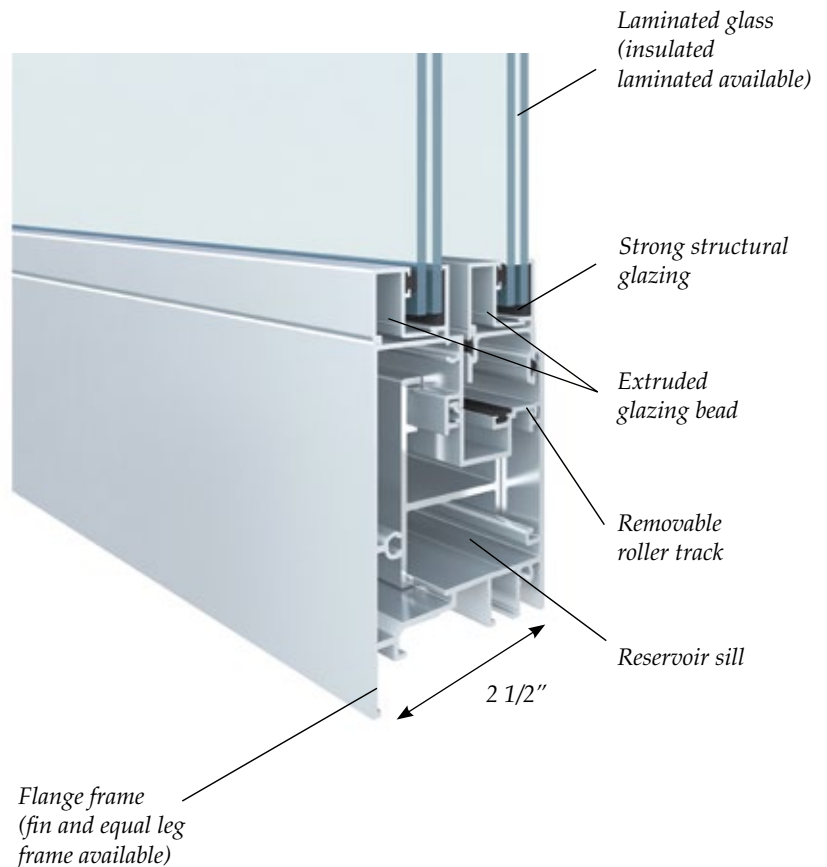
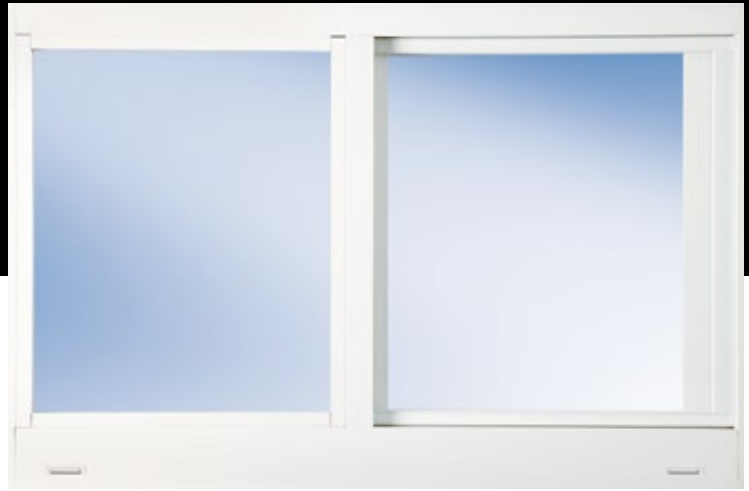

Sentinel Horizontal Rolling Window 120*

Commodity Sizes XO or OX (In inches)

Width	Height	Width	Height	Width	Height	Width	Height
26 1/2	26	37	26	53 1/8	26	74	26
26 1/2	38 3/8	37	38 3/8	53 1/8	38 3/8	74	38 3/8 e
26 1/2	50 5/8	37	50 5/8	53 1/8	50 5/8 e	74	50 5/8 e
26 1/2	63	37	63	53 1/8	63 e	74	63 e

All horizontal rolling windows have a 2 1/2" depth, ideal for replacement applications
e=Meets clear opening egress requirements at 5.7 sq. ft.

* XOX configurations also available

Modular Sizes XO or OX (In inches)

Width	Height	Width	Height	Width	Height	Width	Height	Width	Height	Width	Height	Width	Height
24	24	36	24	48	24	54	24	60	24	66	24	72	24
24	26	36	26	48	26	54	26	60	26	66	26	72	26
24	36	36	36	48	36	54	36	60	36	66	36	72	36
24	38 3/8	36	38 3/8	48	38 3/8	54	38 3/8	60	38 3/8	66	38 3/8	72	38 3/8
24	48	36	48	48	48	54	48	60	48	66	48	72	48
24	50 5/8	36	50 5/8	48	50 5/8	54	50 5/8 e	60	50 5/8 e	66	50 5/8 e	72	50 5/8 e
24	54	36	54	48	54	54	54 e	60	54 e	66	54 e	72	54 e
24	60	36	60	48	60	54	60 e	60	60 e	66	60 e	72	60 e
24	63	36	63	48	63	54	63 e	60	63 e	66	63 e	72	63 e

All horizontal rolling windows have a 2 1/2" depth, ideal for replacement applications

Performance Results

Maximum Water Resistance		12 PSF
Large Missile	2 panel 74" x 63" window (Ann/Ann Glass)	+65 PSF/-65 PSF
	3 panel 111" x 63" window (Ann/Ann Glass)	+65 PSF/-65 PSF
	2 panel 74" x 63" window (HS/HS Glass)*	+80 PSF/-90 PSF
	3 panel 111" x 63" window (HS/HS Glass)*	+80 PSF/-90 PSF
Forced Entry Test (AAMA 1302.5)		Passed

Small missile performance results available upon request.

* Fin frame windows limited to +80 PSF/-80 PSF

Energy Values (NFRC Approved)

Laminated		U Factor	SHGC	VT
5/16"	Clear LoE 366	1.06	0.29	.45
5/16"	Gray	1.03	0.48	.43
5/16"	Clear	1.03	0.57	.64
Insulated Laminated				
3/4"	Clear LoE 366	0.61	0.23	.46
3/4"	Clear LoE 270	0.61	0.29	.50

Available Finishes:

- White, Bronze and Class I Clear Anodized

Standard Glass Colors:

- Clear, Gray, Dark Gray (turtle code), Bronze, Solexia Green, White Interlayer, Mist (Pattern 62), Rain

Glass Types:

- 7/16" Laminated
- 1" Insulated Laminated

Glass Coatings:

- Energy efficient LoE options

Standard Accessories:

- (2) #10-1 1/4" stainless steel fasteners per corner
- Extruded snap-on square glazing beads
- 2 1/2" deep frame
- Strong structural glazing
- Fastener covers

Designer Fixed Windows:

- Half circle
- Arch top/eyebrow
- Full circle
- Octagon
- Hexagon
- Chord
- Tombstone
- Trapezoid
- Pentagon
- Gothic pentagon

Optional Items:

Flange, fin & equal leg frame options

Optional Muntins:

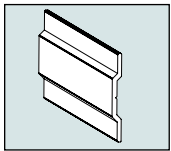

Low Profile

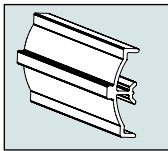

Semi-Contoured (exterior only)

Glass Types:



Laminated Glass



Insulated Laminated Glass

Sentinel Fixed Window 130

Available with Sentinel clipless mullions that are flush on the interior. Installation screw covers and stainless steel package comes standard. Up to 33 sq ft.

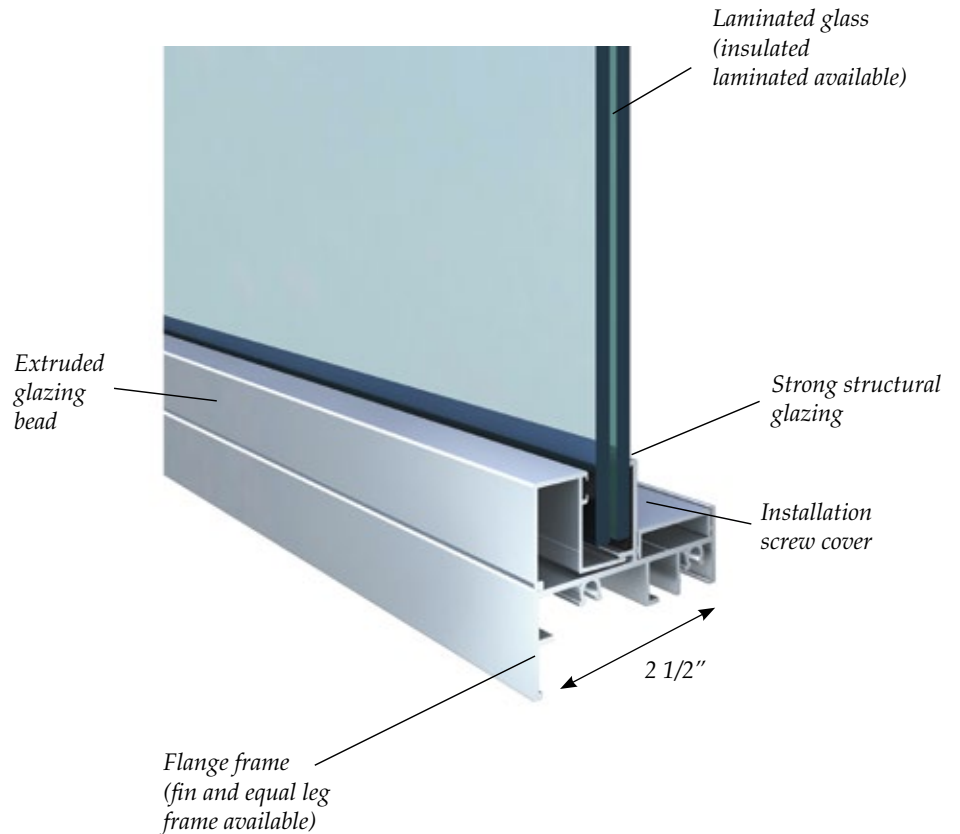
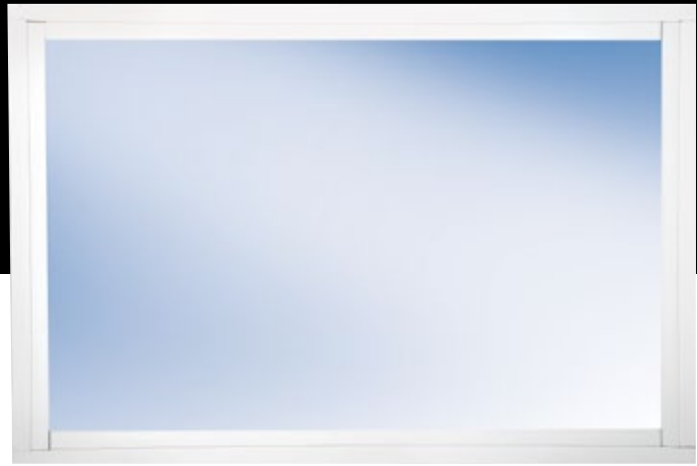

Sentinel Fixed Window 130

Rectangular Fixed Sizes (In inches)

- All fixed windows have a 2 1/2" depth, ideal for replacement applications
- Equal Leg and Fin frame max area is 32 Sq Ft

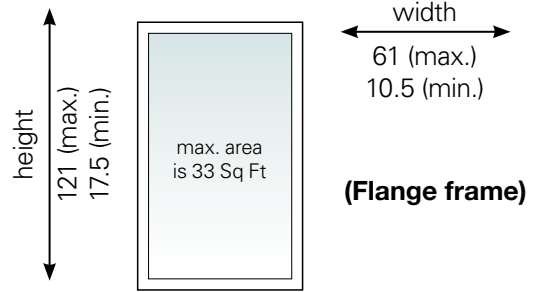

Performance Results

Maximum Water Resistance		12 PSF
Large Missile	49" x 97" window (Ann/HS Glass)	+60 PSF /-60 PSF
	49" x 97" window (HS/HS Glass)	+80 PSF /-80 PSF

Small missile performance results available upon request.

Energy Values (NFRC Approved)

Laminated		U Factor	SHGC	VT
7/16"	Clear LoE 366	1.00	0.33	.51
7/16"	Gray	0.96	0.49	.42
7/16"	Clear	0.96	0.63	.74
Insulated Laminated				
1"	Clear LoE 366	0.42	0.25	.53
1"	Clear LoE 270	0.42	0.32	.57

Available Finishes:

- White, Bronze and Class I Clear Anodized

Standard Glass Colors:

- Clear, Gray, Dark Gray (turtle code), Bronze, Solexia Green, White Interlayer, Mist (Pattern 62), Rain

Glass Types:

- 5/16" Laminated
- 3/4" Insulated Laminated

Glass Coatings:

- Energy efficient LoE options

Standard Hardware:

- Single Stainless Steel arm roto operator and nesting crank handle
- Stainless steel operator track
- Pair of stainless steel four-bar concealed hinges
- Pair of locks (one lock on window under 30" high)
- Pair of stainless steel keepers for above locks
- Snubber blocks
- Small operator on units less than 24", Large operator on units 24" or more

Standard Features:

- Extruded screen frame with Super-View™ mesh
- Extruded snap-on square glazing beads
- Stainless steel assembly screws and corner keys
- Double weatherstripping
- 1/2" Exterior flange frame
- 2" Deep frame

Optional Items:

- Connecting lock bar for egress windows
- Custodial type locks (for institutional use)
- Limit Opening Devices
- Hinges with washability feature (for high-rise use)
- Equal leg frame

Optional Muntins:

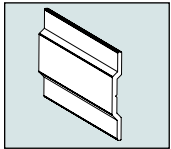

Low Profile

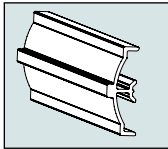

Semi-Contoured (exterior only)

Glass Types:



Laminated Glass



Insulated Laminated Glass

Sentinel Casement Window 238SN

Stainless steel package comes standard including operator and hinges complementing the attractive architectural sightlines.

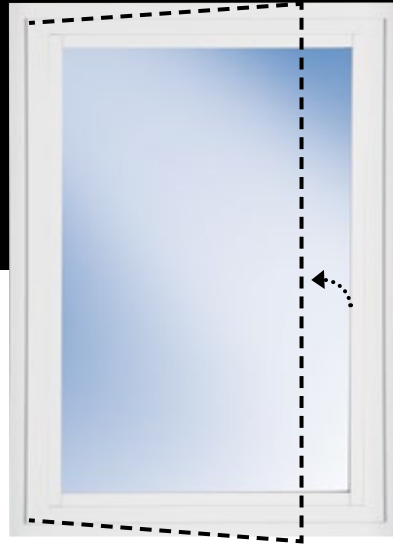

Opens outward from the side

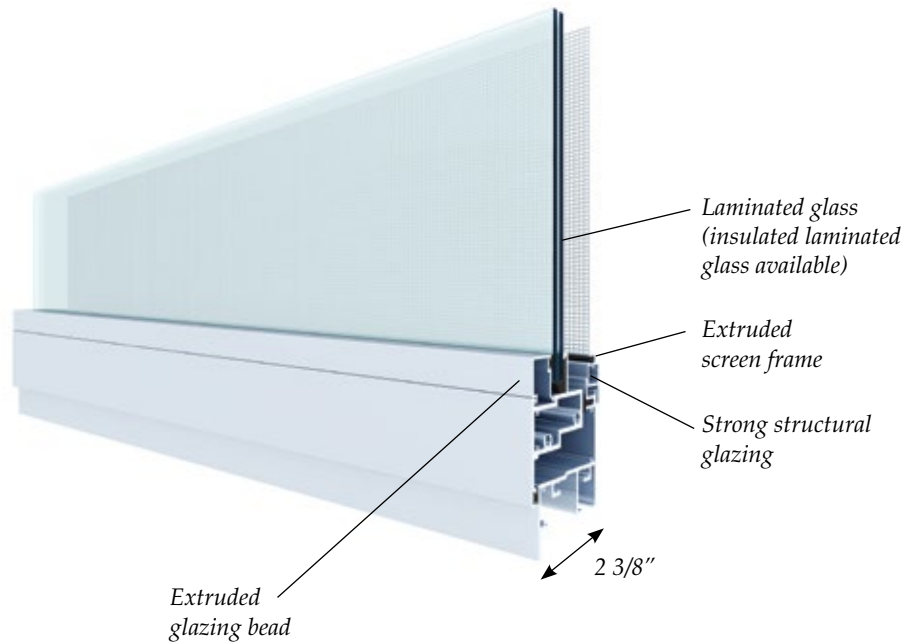

Sentinel Casement Window 238SN

Commodity Sizes (In inches)

Width	Height	Width	Height	Width	Height
19 1/8	17	26 1/2	17	37	17
19 1/8	26	26 1/2	26	37	26
19 1/8	38 3/8	26 1/2	38 3/8	37	38 3/8 e
19 1/8	50 5/8	26 1/2	50 5/8 e	37	50 5/8 e
19 1/8	63	26 1/2	63 e	37	63 e
19 1/8	72	26 1/2	72 e		

e=Meets clear opening egress requirements at 5.7 sq. ft.

Custom Sizes (In inches)

Width		Height	
Minimum available	18	Minimum available	17
Maximum available	42	Maximum available	84

Maximum over-all window area is 16.34 sq ft

Modular Sizes (In inches)

Width	Height	Width	Height	Width	Height	Width	Height	Width	Height	Width	Height
20	24	24	24	28	24	30	24	32	24	36	24
20	30	24	30	28	30	30	30	32	30	36	30
20	36	24	36	28	36	30	36	32	36	36	36 e
20	42	24	42	28	42	30	42 e	32	42 e	36	42 e
20	48	24	48	28	48 e	30	48 e	32	48 e	36	48 e
20	54	24	54	28	54 e	30	54 e	32	54 e	36	54 e
20	60	24	60	28	60 e	30	60 e	32	60 e	36	60 e
20	66	24	66	28	66 e	30	66 e	32	66 e		
20	72	24	72	28	72 e	30	72 e	32	72 e		
20	78	24	78	28	78 e						
20	84	24	84								

e=Meets clear opening egress requirements at 5.7 sq. ft.

Performance Results

Maximum Water Resistance		16.5 PSF
Large Missile	20" x 36" window (Ann/Ann Glass)	+110/-194.3 PSF
	37" x 63" window (Ann/Ann Glass)	+/-60 PSF
Forced Entry Test (AAMA 1302.5)		Passed

Energy Values (NFRC Approved)

Laminated		U Factor	SHGC	VT
5/16"	Gray	1.04	0.44	.39
5/16"	Clear	1.04	0.53	.59
Insulated Laminated				
3/4"	Clear LoE 366	0.63	0.21	.42
3/4"	Clear LoE 270	0.63	0.27	.46

Available Finishes:

- White, Bronze and Class I Clear Anodized

Standard Glass Colors:

- Clear, Gray, Dark Gray (turtle code), Bronze, Solexia Green, White Interlayer, Mist (Pattern 62), Rain

Glass Types:

- 5/16" Laminated
- 3/4" Insulated Laminated

Glass Coatings:

- Energy efficient LoE options

Standard Hardware:

- Dual Stainless Steel arm roto operator and crank handle
- Stainless steel operator track
- Pair of stainless steel four-bar concealed hinges
- Pair of locks
- Pair of stainless steel keepers for above locks
- Snubber blocks
- Small arm operator on units less than 32"
- Large arm operator on units 32" or more

Standard Features:

- Extruded screen frame with Super-View™ mesh
- Extruded snap-on square glazing beads
- Stainless steel assembly screws and corner keys
- Double weatherstripping
- 1/2" Exterior flange frame
- 2" Deep frame

Optional Items:

- Custodial type locks (for institutional use)
- Limit Opening Devices
- Collapsible crank handle
- Equal leg frame

Optional Muntins:

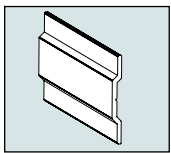

Low Profile

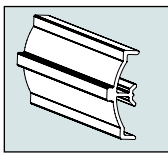

Semi-Contoured (exterior only)

Glass Types:



Laminated Glass



Insulated Laminated Glass

Sentinel Project Out Window 238SN

Stainless steel package comes standard including operator and hinges complementing the attractive architectural sightlines.

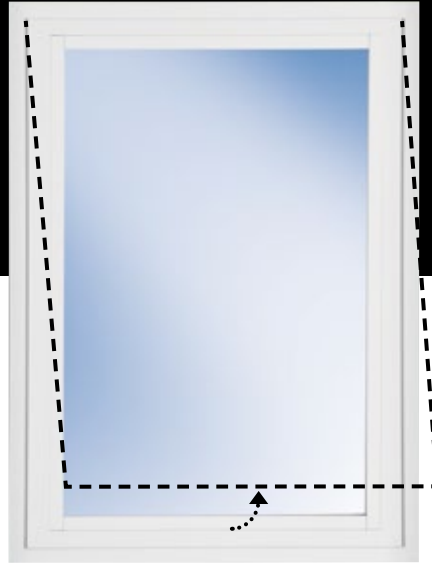

Opens outward from the bottom

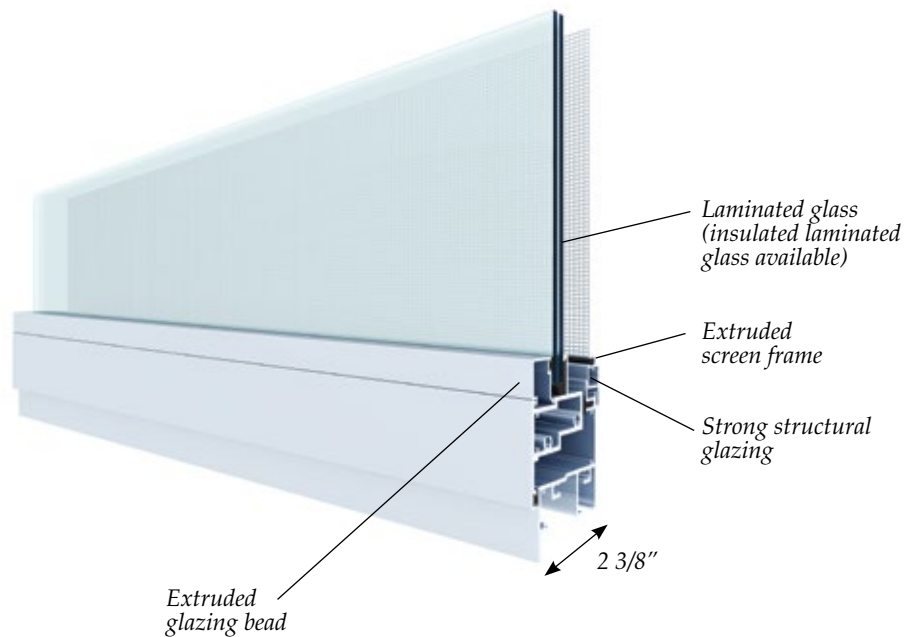

Sentinel Project Out Window 238SN

Commodity Sizes (In inches)

Width	Height	Width	Height	Width	Height
19 1/8	17	26 1/2	17	37	17
19 1/8	26	26 1/2	26	37	26
19 1/8	38 3/8	26 1/2	38 3/8	37	38 3/8
19 1/8	50 5/8	26 1/2	50 5/8	37	50 5/8
19 1/8	63	26 1/2	63	37	63
19 1/8	72	26 1/2	72		

Custom Sizes (In inches)

Width		Height	
Minimum available	18	Minimum available	17
Maximum available	84	Maximum available	84

Maximum over-all window area is 16.34 sq ft

Modular Sizes (In inches)

WxH	WxH	WxH	WxH	WxH	WxH	WxH	WxH	WxH	WxH	WxH	WxH	WxH
20x24	24x24	28x24	30x24	32x24	36x24	40x24	42x24	48x24	54x24	60x24	66x24	72x24
20x30	24x30	28x30	30x30	32x30	36x30	40x30	42x30	48x30	54x30	60x30	66x30	72x30
20x36	24x36	28x36	30x36	32x36	36x36	40x36	42x36	48x36	54x36	60x36		
20x42	24x42	28x42	30x42	32x42	36x42	40x42	42x42	48x42	54x42			
20x48	24x48	28x48	30x48	32x48	36x48	40x48	42x48	48x48				
20x54	24x54	28x54	30x54	32x54	36x54	40x54	42x54					
20x60	24x60	28x60	30x60	32x60	36x60							
20x66	24x66	28x66	30x66	32x66								
20x72	24x72	28x72	30x72	32x72								
20x84	24x84											

All window dimensions shown are tip to tip of exterior 1/2" flange on frame. Do not use Project Out windows where Egress (Emergency Escape) is required. Use of small arm operator will limit window opening (ventilation) to 2 3/4". Use of large arm operator will limit window opening (ventilation) to 8".

Performance Results

Maximum Water Resistance		16.5 PSF
Large Missile	24" x 36" window (Ann/Ann Glass)	+110/-161.9 PSF
	37" x 63" window (Ann/Ann Glass)	+/-60 PSF
Forced Entry Test (AAMA 1302.5)		Passed

Energy Values (NFRC Approved)

Laminated		U Factor	SHGC	VT
5/16"	Gray	1.07	0.44	.39
5/16"	Clear	1.07	0.53	.59
Insulated Laminated				
3/4"	Clear LoE 366	0.63	0.21	.42
3/4"	Clear LoE 270	0.63	0.27	.46

Available Finishes:

- White, Bronze and Class I Clear Anodized

Standard Glass Colors:

- Clear, Gray, Dark Gray (turtle code), Bronze, Solexia Green, White Interlayer, Mist (Pattern 62), Rain

Glass Types:

- 7/16" Laminated
- 1" Insulated Laminated

Glass Coatings:

- Energy efficient LoE options

Standard Hardware:

- Interior lock and handle
- Stainless steel rollers
- White, Bronze or Gray handles

Standard Features:

- 2-, 3- & 4-track and pocketed configurations
- 4 3/4" deep frame on 2-track
- 6" deep frame on 3-track
- 7 3/4" deep frame on 4-track
- Mitered decorative interior corners
- Stainless steel fasteners
- Heavy duty extruded screen frame with Super-View™ fiberglass mesh
- 2-point lock
- Concealed installation screws

Optional Items:

- Exterior keyed security lock
- Dual track extruded screen frame with Super-View™ fiberglass mesh for use with 3-track configurations

Optional Muntins:

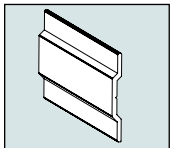

Low Profile

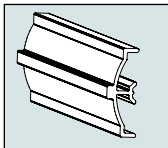

Semi-Contoured (exterior only)

Glass Types:



Laminated Glass



Insulated Laminated Glass

Sentinel Sliding Glass Door 150

Now with concealed fasteners, 2 point lock and updated door stop. Stainless steel package comes standard and the 4.75" 2-track depth allows for easy retrofit install. Available in 2 or 3 track configurations and pockets.

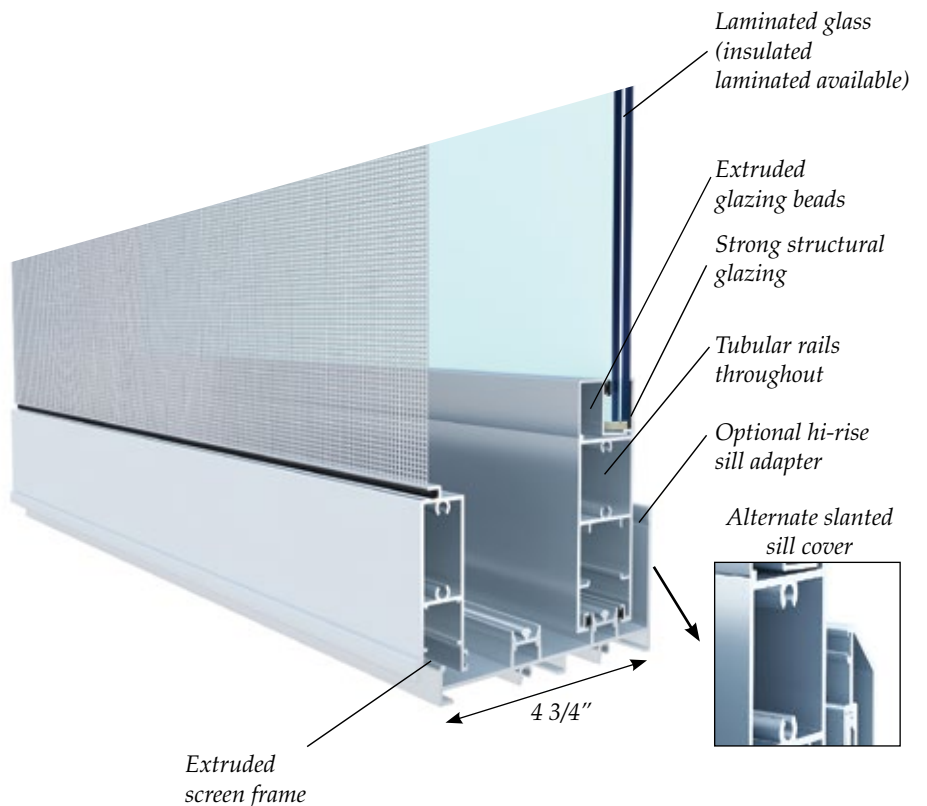

Sentinel Sliding Glass Door 150*

Door Sizes

Sentinel 6'8" and 8'0" Sliding Glass Door Sizes (80" and 96" frame height)

2-Track Configuration	Call Width	Frame Width	3-Track Configuration	Call Width	Frame Width	4-Track Configuration	Call Width	Frame Width
OX, XO XX-R, XX	4-0	48"	XXX, XXO	7-6	88 1/16"	XXXO, OXXX, XXXX, XXXXR	10-0	116 1/16"
	5-0	60"		XXX-R, OXX	9-0		106 1/16"	12-0
	6-0	72"		12-0	142 1/16"		16-0	188 1/16"
	8-0	96"		18-0	212 1/16"			
OXO, OXO-R	9-0	108 3/8"					20-0	230 1/16"
	12-0	144 3/8"					24-0	278 9/16"
OXXO, XXXX	10-0	118 7/16"	OXXXXO, XXXXXX	15-0	174 5/8"		32-0	374 9/16"
	12-0	142 7/16"		18-0	210 5/8"		36-0	422 9/16"
	16-0	190 7/16"		24-0	282 5/8"			

Pocket configurations available

Performance Results

Maximum Water Resistance	Without waterbar adapter	9 PSF
	With waterbar adapter	12 PSF
Large Missile	4' x 8' Panel (Ann/HS Glass)	+60 PSF /-60 PSF
	4' x 8' Panel (HS/HS Glass)	+80 PSF /-80 PSF
	4' x 10' Panel (Ann/HS Glass)	+60 PSF /-60 PSF
Forced Entry Test (AAMA 1302.5)		Passed

Energy Values (NFRC Approved)

Laminated		U Factor	SHGC	VT
7/16"	Clear LoE 366	1.02	0.29	.44
7/16"	Gray	1.03	0.43	.37
7/16"	Clear	1.03	0.56	.65
Insulated Laminated				
1"	Clear LoE 366	0.56	0.22	.46
1"	Clear LoE 270	0.56	0.28	.50

Available Finishes:

- White, Bronze and Class I Clear Anodized

Standard Glass Colors:

- Clear, Gray, Dark Gray (turtle code), Bronze, Solexia Green, White Interlayer, Mist (Pattern 62), Rain

Glass Types:

- 7/16" Laminated
- 1" Insulated Laminated

Glass Coatings:

- Energy efficient LoE options

Standard Hardware:

- Patented concealed 3-point lock
- Aluminum hinges

Standard Features:

- Extruded snap-on square glazing beads
- 4" deep frame
- Fastener covers
- Triple weatherstripping
- Outswing configuration
- Square or slanted sill cover

Optional Items:

- Brushed Satin, Tuscan Bronze or Polished Brass levers
- Free-Standing and Self-Mating Sidelites
- ADA saddle threshold [coming soon]
- Hardware package upgrade

Optional Muntins:

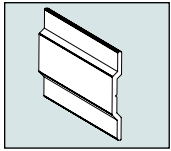

Low Profile

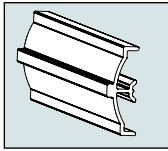

Semi-Contoured (exterior only)

Glass Types:



Laminated Glass



Insulated Laminated Glass

Sentinel French Door 160

Comes standard with CGI patented 3-point lock and stainless steel package. Available with self-mating sidelites. 4" frame depth allows for easy retrofit install. Slanted or square sill covers

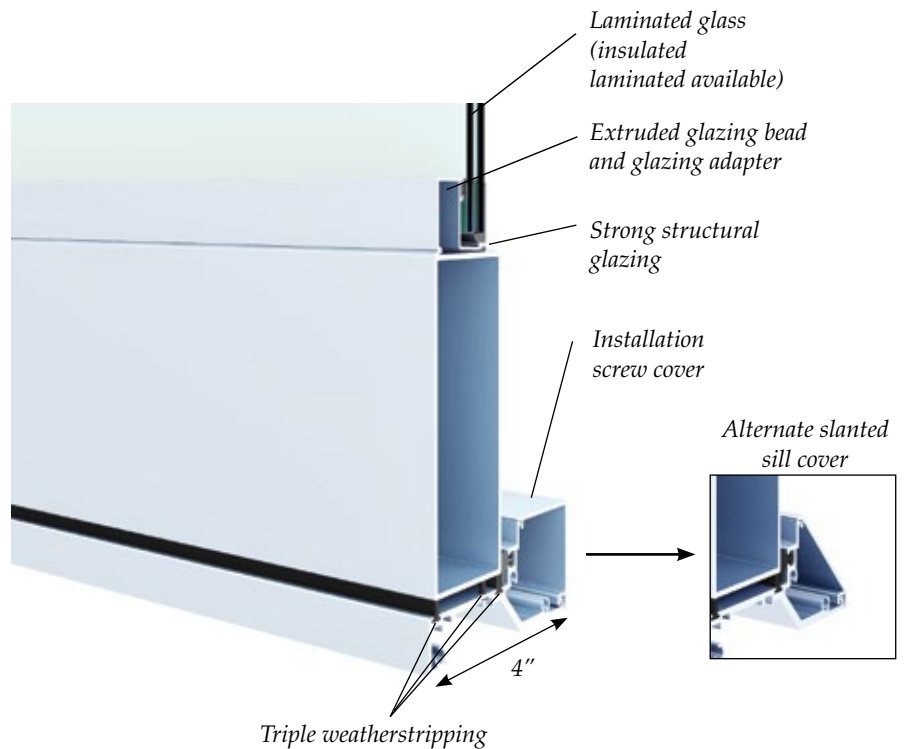

Sentinel French Door 160

Door Sizes (In inches)

Single						Double					
6' 8"			8' 0"			6' 8"			8' 0"		
Code Size	Width	Height	Code Size	Width	Height	Code Size	Width	Height	Code Size	Width	Height
2668	31 1/4	80	2680	31 1/4	96	4068	48	80	4080	48	96
2868	33 1/4	80	2880	33 1/4	96	5068	60	80	5080	60	96
3068	37 1/4	80	3080	37 1/4	96	5468	64	80	5480	64	96
4068	42	80	4080	42	96	6068	72	80	6080	72	96
						6968	81 1/2	80	6980	81 1/2	96

Free-Standing or Self-Mating Sidelites (In inches)

6'8"				8'0"			
Width		Height		Width		Height	
12		80		12		96	
18		80		18		96	
24		80		24		96	
30		80		30		96	
33		80		33		96	
36		80		36		96	
37 1/8		80		37 1/8		96	
42		80		42		96*	

* IG only

Performance Results

Maximum Water Resistance		12 PSF
Large Missile	3' x 8' Panel (Ann/Ann Glass)	+80 PSF /-80 PSF
Forced Entry Test (AAMA 1302.5)		Passed

Energy Values

Laminated		Single Door/ Pair of Door			Self-Mating/ Free-Standing Sidelite		
		U Factor	SHGC	VT	U Factor	SHGC	VT
7/16"	Clear LoE 366	1.03	.24	.32	1.04	.28	.41
7/16"	Clear	1.03	.43	.47	1.03	.52	.59
7/16"	Gray	1.03	.34	.26	1.03	.41	.33
Insulated Laminated							
1"	Clear LoE 366	.69	.19	.33	.59	.22	.42
1"	Clear LoE 270	.69	.23	.36	.59	.27	.45

Available Finishes:

- White, Bronze and Class I Clear Anodized

Standard Glass Colors:

- Clear, Gray, Dark Gray (turtle code), Bronze, Solexia Green, White Interlayer, Mist (Pattern 62), Rain

Glass Types:

- 5/16" Laminated (Window)
- 7/16" Laminated (Door)
- 3/4" Laminated (Window)
- 1" Insulated Laminated (Door)

Glass Coatings:

- Energy efficient LoE options

Standard Hardware:

- Patented concealed 3-point lock
- Aluminum hinges

Standard Features:

- Extruded snap-on square glazing beads
- 4.5" deep frame
- Fastener covers
- Triple weatherstripping
- Inswing or Outswing configuration

Optional Items:

- Brushed Satin, Tuscan Bronze or Polished Brass levers
- Muntins-Grille between glass or Double applied
- Extruded aluminum screen

Details:

- Max single hung size: 30 3/8" x 50 5/8"
- Max panel size 42" x 102"
- Bottom aluminum panel also available

Optional Muntins:

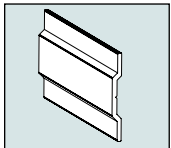

Low Profile

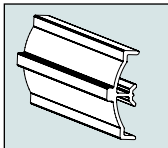

Semi-Contoured (exterior only)

Glass Types:



Laminated Glass



Insulated Laminated Glass

Sentinel Balcony Breeze Door 165

Available in inswing and outswing configurations includes CGI's patented 3-point lock and stainless steel package along with an integrated single hung within the door panel.

The single hung can be located either at the top or bottom of the door with the option for aluminum or glass in the other half. The 4.5" frame depth allows for easy installation whether new or retrofit application



Extruded glazing bead

Laminated glass (insulated laminated available)

Continuous lift rail

Strong structural glazing

Captured bottom rail design

Aluminum window adaptor

Integrated (true muntin) for door panel

Laminated glass (insulated laminated available)
Aluminum pnael available

Sentinel French Door 160

Door Sizes (In inches)

6' 8"			8' 0"		
Code Size	Width	Height	Code Size	Width	Height
2668	32 9/16"	80 3/4"	2680	32 9/16"	96 3/4"
2868	34 9/16"	80 3/4"	2880	34 9/16"	96 3/4"
3068	38 9/16"	80 3/4"	3080	38 9/16"	96 3/4"
Max Panel Size 42" x 102"					

Performance Results

Maximum Water Resistance		13.5 PSF
Large Missile	42"x102" Panel (HS/HS Glass)	+90 PSF /-110 PSF
Forced Entry Test (AAMA 1302.5)		Passed



INVENT. BUILD. DELIVER.

THE PGT INNOVATIONS FAMILY OF BRANDS

